

TRESTON

Packing solutions



FROM AN ALL-IN-ONE PACKING TABLE TO A COMPLETE PACKAGING SOLUTION



Product solutions for more efficiency in in-house logistics

As a specialist for in-house logistics workstations, Treston offers ergonomic, modular and innovative workplace systems that are geared towards the future thanks to their high level of adaptability.

Sensibly organised and ergonomically designed packing workstations are the key to efficient workflows in shipping and logistics. The basis for fast and precise work is formed by workstations that can be individually combined and expanded at any time.

With our smart packing workstations and material flow solutions, we contribute to safe, lean and environmentally friendly processes, to flexible adaptation in the event of changes as well as to improved efficiency and thus ultimately to increased productivity in logistics.



Work smarter, not harder

Customised and flexible solutions



As a manufacturer with our own factories in Finland, we are able to offer solutions tailored to the customer - regardless of whether these are standard products that can be costeffectively integrated into any working environment thanks to their modularity and comprehensive accessories, or customised product solutions. Depending on the size and requirements of the project, we also realise test set-ups on site.

We listen and we question. Our project managers take the time to individually address your needs, wishes and the processes to be considered. Based on your requirements, we create proposals and 3D drawings to design the right workplace solution and environment for you.

Why select Treston?

For over 50 years, Treston has designed and manufactured high quality industrial furniture which is functional and efficient, tailor-made for the person performing the job. No matter if you choose an out-of-the-box solution or a tailor-made solution, the design always has ergonomics and efficiency aspects in mind.

Our skillful staff has worked with over 600,000 deliveries world-wide. Whether you need space planning, 5S integration, prototypes, installation or training services – we are here for you. With an unmatched track record of projects, no matter how big or small we can help you choose just the right solution for your needs.

TRESTON WARRANTY PERIOD

The guarantee period for Treston™ products is 10 years from the date of delivery with some exceptions.

For plastic bins guarantee is 5 years. The warranty period for worksurfaces, electric components, saddle chairs, lights, and normal wear and tear items such as castors, slides and roll profiles is 2 years. For trading products and components as well as custom-made articles we guarantee 2-year warranty unless otherwise agreed.



Why invest in a packing bench?



Are you looking for an easy packing bench option or a packaging solution which can answer varying needs and is highly adjustable? Treston packing bench options can answer both these needs. In addition to benches, Treston can also offer matching trolleys, cabinets, lights, chairs and more to complete a fully functional workstation.

An ergonomic workstation, where everything is in its place, enables faster and more accurate packing, improves safety, makes it easier to switch between packing personnel and creates a clean and less-stressful atmosphere. Improved efficiency makes larger volumes and more revenue opportunities possible.

- ✓ **Improve efficiency, accuracy and safety**
- ✓ **Make it easy to switch between packing personnel**
- ✓ **Create a clean and less-stressful environment, thus energizing packing personnel**
- ✓ **Enable larger volumes and more revenue opportunities**

TPB packing bench, page 8

- Safe, economic and ergonomic all-in-one packing bench
- Adapts and grows according to needs
- 50+ accessories and add-on products available
- Steel frame with loading capacity up to 300 kg



300 kg



Concept workbench, page 10

- Multiple bench variations with advanced ergonomic features
- Superior range of accessories, easily reconfigured
- Excellent stability, suitable for heavy loads up to 500 kg



500 kg



Treston QuatreX workbench, page 12

- Electrical workbench specifically designed to offer supreme stability, flexibility, and precision
- Flexibility and versatility – choose perforated or aluminium uprights
- Maximum load capacity 300 kg



300 kg



TED electric desk, page 14

- TED Electric Desk comes with quick, silent and wide height adjustment
- The desk can be customized with accessories which further enhance ergonomics, free desk space and provide order
- Maximum load capacity 200 kg



200 kg



Quick Edge workstation, page 16

- The quickest height adjustment on the market - no electricity needed
- Multiple accessories available: swivel arms for tool holders and screens, LED lights, shelves with dividers for cartons
- Maximum load capacity 100 kg



100 kg





Fully functioning packaging area

Whether you handle, wrap, pack or unpack big or small materials and items, they need to be stored, lifted, or brought via a belt conveyor system to the packing table and removed from the workstation.

To create a fully functioning packaging area, Treston's offering also includes a variety of trolleys, cabinets and shelves which are an integral part of a good packing environment. Treston packaging tables, together with industrial complementing furniture, help you maximize production and speed up the packaging process. Also, don't forget chairs and good lighting – both elements which complete a well-functioning packaging station.

All Treston furniture and packing table designs take into account ergonomic aspects, enabling you to keep all packaging materials within easy reach.

Please see Treston's entire product selection in our Main catalogue.

treston.com/catalogues-and-brochures

Our vision of the ideal in-house logistics workstation

LEAN-compatible
and adaptable to new requirements and activities

Ergonomic
for maintaining the health, job satisfaction and motivation of employees

Sustainable
due to high quality and excellent functionality

Modular
and well suited to the various needs of in-house logistics

Packing material roll stands and cutters, page 32

- Sturdy, freestanding, multipurpose stands for rolls of packing material, for example.



Trolleys for packing, page 34

- Ergonomic, light-to-move packing trolleys make it easy to transport goods, packing materials and tools and improve efficiency and productivity at work.



Please visit treston.com for more packing products

- Storage systems
- Drawer units
- Lighting
- Task chairs



Treston Packing Bench TPB

A well thought-out, safe and easy all-in-one choice



- ✓ Safe, economic and ergonomic all-in-one choice
- ✓ Adapts and grows according to needs
- ✓ 50+ accessories and add-on products available
- ✓ One flat pack contains all the basic equipment
- ✓ Easy to buy, transport and assemble

This packing table adapts and grows according to your needs. You don't need to know what your business will look like in two years' time, as you can add and remove accessories as you go. Start small and add from over 50 accessories based on your needs. TPB comes in one flat pack and is easy to assemble. Perfect packing table option for cost-conscious users.

Carefully selected materials, high-quality finishing, epoxy powdercoated steel parts RAL 7035. Laminate bench top, 25 mm low-pressure laminate.

Packing bench TPB

Size W x D mm	Max load kg	Code
1500 x 900 x 650-900	300	TPB915
1800 x 900 x 650-900	300	TPB918

The TPB packing bench comes with a full set of basic accessories. The package includes 2 roll holders, perforated panel, upper steel shelf, divider hoops and an auxiliary steel shelf.

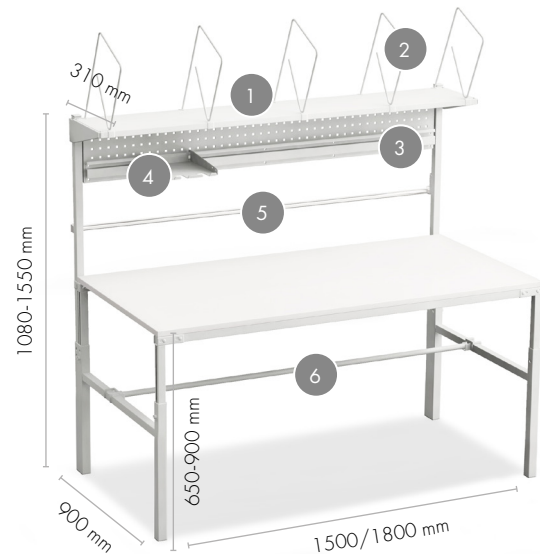

Packing bench TPB915/TPB918 includes:

Name	Description	Code TPB915	Code TPB918
1. Height adjustable upper steel shelf	Size 310 x 1500/1800 mm. Max load 30 kg. Fixing positions for Treston lighting units under the shelf.	SS150	SS180
2. Adjustable divider hoops	Five adjustable divider hoops (height 400 mm).	PDH	PDH
3. Height adjustable steel perforated panel with bin rail	Size of the panel 1419/1719 x 255 mm. For auxiliary steel shelves and stacking bins. Max load 20 kg.	PP150	PP180
4. Auxiliary steel shelf	Size 217 x 298 x 20 mm, for A4 paper and tape dispensers (max 2 pcs per shelf). Max load 3 kg.	ASSA4	ASSA4
5. Upper paper roll holder	Height adjustable. Axle diameter 25 mm. Max roll width 1400/1700 mm. Max load 40 kg.	PRH ROLL150	PRH ROLL180
6. Lower paper roll holder	Simply hangs on horizontal bars of legs. Depth adjustable. Axle diameter 25 mm. Max roll width 1350/1650 mm. Max load 40 kg.	PRHL ROLL150	PRHL ROLL180

TPB packing station example



+

Accessories on pages 27-32

See additional accessories, lighting units, paper roll holders and cutters.

Qty	Name	Size mm	Code
1	Packing bench	1800 x 900	TPB918
1	Tool and lighting support	1800	KT180
1	Treston NaturLite LED 1200	1180	TNL1200
1	Recycling material bin	530 x 280 x 585	PRMB
1	Cutter	1785 x 130 x 200	PPC180
1	Side worktop	400 x 900	TP904ST
1	Tool holder box	400 x 300 x 150	PPH TXL
1	Lower steel shelf	1718 x 460	LSS180
1	Low M-divider hoops (4 pcs/set)	460 x 315	LDH
2	Auxiliary steel shelf	217 x 298	ASSA4
1	Basic label dispenser	214 x 128 x 120	BLD20
1	Fixed tape dispenser		FTD50
1	Paper roll dividers		RD25
1	Stacking bin	149 x 250 x 130	1525-6
1	Stacking bin	186 x 300 x 156	1930-6

Treston Concept bench

Accommodates the most demanding needs



- ✓ For all packaging needs, no need for compromises!
- ✓ Wide variety of modules, options and variations
- ✓ Largest number of accessories on the market
- ✓ Sturdy, stable, high-quality

Whatever the variation you need, you can build it from Concept and its modular elements. Modules fit together seamlessly, giving you an opportunity to create a complete packaging solution, perfectly matching your needs.

Building packaging combinations from varying, yet standard modules makes it possible to create an ergonomically well-functioning packaging solution which is also robust and economic. No need for costly extra modifications or compromises!

Concept workbench frame

Workbench frame size W x D mm	Allen key adjustable Code	Bench frame max load kg	Hand crank adjustable Code	Bench frame max load kg	Electric adjustable Code	Bench frame max load kg
1200 x 750	100 49 031P	500	101 49 031	200	103 49 031P	400
1200 x 900	100 49 063P	500	101 49 063	200	103 49 063P	400
1500 x 750	100 49 032P	500	101 49 032	200	103 49 032P	400
1500 x 900	100 49 064P	500	101 49 064	200	103 49 064P	400
1800 x 750	100 49 033P	500	101 49 033	200	103 49 033P	400
1800 x 900	100 49 065P	500	101 49 065	200	103 49 065P	400
2000 x 750	100 49 034P	500			103 49 034P	400
2000 x 900	100 49 066P	500			103 49 066P	400
Bench height steplessly adjustable	670 - 1100 mm		675 - 1025 mm		700 - 1100 mm Height adjustment speed 13 mm / second	

Concept bench tops

Size W x D mm	Code	Code	Code
	High pressure laminate	Low pressure laminate	ESD laminate
1200 x 750	TT12075-HPL	TT12075-LPL	TT12075-ESD
1200 x 900	TT12090-HPL	TT12090-LPL	TT12090-ESD
1230 x 750	TT12375-HPL	TT12375-LPL	TT12375-ESD
1230 x 900	TT12390-HPL	TT12390-LPL	TT12390-ESD
1500 x 750	TT15075-HPL	TT15075-LPL	TT15075-ESD
1500 x 900	TT15090-HPL	TT15090-LPL	TT15090-ESD
1530 x 750	TT15375-HPL	TT15375-LPL	TT15375-ESD
1530 x 900	TT15390-HPL	TT15390-LPL	TT15390-ESD
1806 x 750	TT18075-HPL	TT18075-LPL	TT18075-ESD
1806 x 900	TT18090-HPL	TT18090-LPL	TT18090-ESD
1836 x 750	TT18375-HPL	TT18375-LPL	TT18375-ESD
1836 x 900	TT18390-HPL	TT18390-LPL	TT18390-ESD
2000 x 750	TT20075-HPL	TT20075-LPL	TT20075-ESD
2000 x 900	TT20090-HPL	TT20090-LPL	TT20090-ESD
2030 x 750	TT20375-HPL	TT20375-LPL	TT20375-ESD
2030 x 900	TT20375-HPL	TT20375-LPL	TT20390-ESD

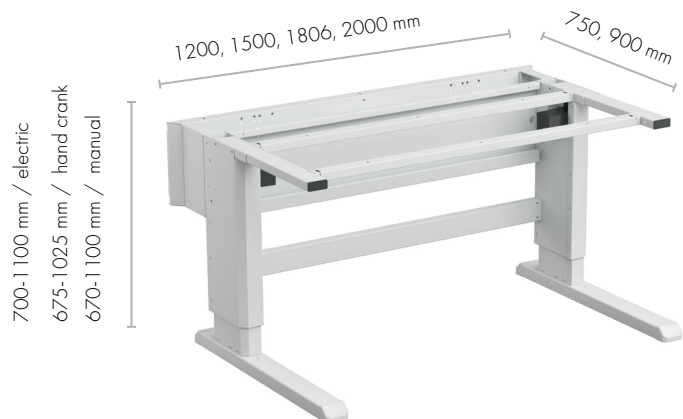

Concept packing station example



Accessories on pages 18-32

See additional accessories, lighting units, paper roll holders and cutters.



Castor set Ø100 Code 834 734 -00

Castor set Ø100 ESD Code 860 429 -00

Load capacity with castors 300 kg. Always adjust the bench with castors to the lowest position when the bench is moved.

Qty	Name	Size mm	Code
1	Bench frame, motor adjustable	1800 x 900	103 49 065P
1	Laminate HPL bench top	1806 x 900	TT18090-HPL
1	Upright tube modules 2 x M900	Height 1359	UTM2X900M-49
1	Light and balancer rail 2 x M900	1800	918 49 008P
1	Treston NaturLite LED 1200	1180	TNL1200
1	Tiltable top shelf M900	870 x 400	TTSM9004-49
1	Divider hoops set (4 pcs)	400 x 400	PDH400-49
1	Aluminium bin rail M900	889 x 55 x 75	BP900C
3	Auxiliary steel shelf	217 x 298	ASSA4
1	Basic label dispenser	214 x 128 x 120	BLD20
1	Fixed tape dispenser		FTD50
1	Roll holder set M900	Max roll length 785 mm	890 548-49P
1	Paper roll dividers		RD25
1	Perforated back panel M900	878 x 389	861 516-49
1	LCD holder with double arm		930 49 002P
1	Keyboard and mouse tray for LCD holder	620 x 260	860 942-49
1	Adjustable auxiliary shelf	560 x 340	927 41 001P
1	Pull-out steel shelf for printer	500 x 510 x 515	PSP50
1	Shelf for packing material M900	870 x 600	SPM900-49
1	Adjustable fastening set under worktop	90 x 350 x 355	SPMAF-49
1	Divider hoops set (4 pcs)	400 x 280	PDH600-49

Treston QuatreX bench

Stability, speed and precision



- ✓ **Extreme stability and less vibration**
- ✓ **Flexibility and versatility - choose perforated or aluminium uprights**
- ✓ **Four powerful motors offer the fastest adjusting speed we have ever designed for electrical workbenches**

Treston QuatreX electrical workbench is specifically designed to offer supreme stability, flexibility, and precision. With modern and ergonomic design combined with the highspeed electrical height adjustment this workbench is the ultimate choice for professionals who demand excellence in their work environments.

Treston QuatreX is our first workbench capable of utilising both, upright tube and aluminium upright profiles, offering unparalleled flexibility in workstation configuration. Additionally, accessories designed for perforated upright tubes can be easily attached to aluminium uprights with the use of adapters.

Treston QuatreX bench frame

Name	Size W x D mm	Max load kg	Code
Four-leg electric bench frame	1025 x 750	300	QX10375-41
Four-leg electric bench frame	1225 x 750	300	QX12375-41
Four-leg electric bench frame	1525 x 750	300	QX15375-41
Four-leg electric bench frame	1825 x 750	300	QX18375-41
Four-leg electric bench frame	2025 x 750	300	QX20375-41
Four-leg electric bench frame	1025 x 900	300	QX10390-41
Four-leg electric bench frame	1225 x 900	300	QX12390-41
Four-leg electric bench frame	1525 x 900	300	QX15390-41
Four-leg electric bench frame	1825 x 900	300	QX18390-41
Four-leg electric bench frame	2025 x 900	300	QX20390-41
ESD Grounding set for Treston QuatreX			QX-ESD
Height adjustment speed 36 mm / second			

Treston QuatreX bench tops

Size W x D mm	Code HPL	Code LPL	Code ESD
1030 x 750	TT10375-HPL	TT10375-LPL	TT10375-ESD
1030 x 900	TT10390-HPL	TT10390-LPL	TT10390-ESD
1230 x 750	TT12375-HPL	TT12375-LPL	TT12375-ESD
1230 x 900	TT12390-HPL	TT12390-LPL	TT12390-ESD
1530 x 750	TT15375-HPL	TT15375-LPL	TT15375-ESD
1530 x 900	TT15390-HPL	TT15390-LPL	TT15390-ESD
1836 x 750	TT18375-HPL	TT18375-LPL	TT18375-ESD
1836 x 900	TT18390-HPL	TT18390-LPL	TT18390-ESD
2030 x 750	TT20375-HPL	TT20375-LPL	TT20375-ESD
2030 x 900	TT20390-HPL	TT20390-LPL	TT20390-ESD

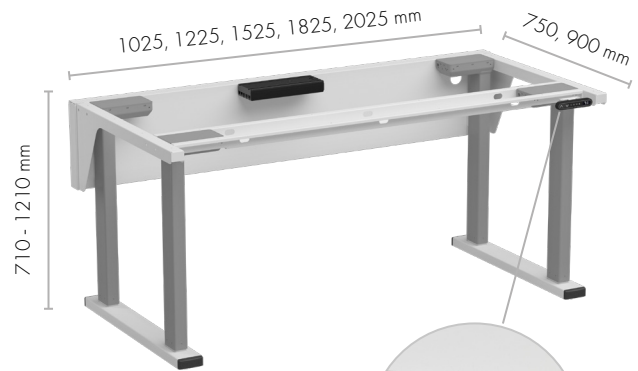

Side plates

Name	Size mm	Code
Side plates for Treston QuatreX	depth 750	SPQX750-49
Side plates for Treston QuatreX	depth 900	SPQX900-49

The optional side plates, available as an accessory, ensure a safe environment when two tables are used side by side. Includes two plates, right hand and left hand versions.

QuatreX packing station example



+ **Accessories on pages 18-32**
 QuatreX is the first Treston workbench to utilize both upright tubes, and aluminium upright profiles, offering more flexibility in workstation setup.



The QuatreX bench can be equipped with castors!

Castor set Ø100 ESD Code LCS100
Castor set Ø100 Code LCS100 ESD

Load capacity with castors 300 kg. Always adjust the bench with castors to the lowest position when the bench is moved.

Qty	Name	Size mm	Code
1	QuatreX electric bench frame	1525 x 750	QX15375-41
1	Laminate bench top	1530 x 750	TT15375-LPL
1	Upright tube module, 1359 mm	2 x M500	UTM2X500M-49
1	Recycling material bin		PRMBQX
1	Shelf for packing material	1167 x 600 x 32	SPM1200-49
1	Adjustable fastening set under worktop		SPMAF-49
1	Divider hoops set	400 x 280	PDH600-49
1	Side plate	depth 750	SPQX750-49
1	Printer platform slideable	315 x 530	859 060-49
1	LCD swivel arm		MA
1	Tablet bracket		MY
1	Perforated back panel	968 x 389	861 532-49
1	Tape roll storage rack for perforated panel	122 x 110 x 254	TRRP-49
2	Treston NaturLite Led Wing	500	TNL500W
1	Tilttable top shelf	967 x 300	TTSM10003-49
1	Bottle holder	Ø 100	859 063-49
1	Tool tray	1000 x 60	PTH100

Treston Electric Desk TED

Quick, silent and wide height adjustment



- ✓ Wide height adjustment range 630–1270 mm
- ✓ Quick and silent adjustment, 22 mm per second
- ✓ Customisable with additional above-desk accessories which free desk space and further improve order and ergonomics

Treston Electric Desk TED adjusts to different heights quickly and silently, extending from as low as 630 mm all the way up to 1270 mm. Accommodating a wide range of heights serves especially well in packing applications, where the handled items can vary from big to small. A desk with a quick and wide adjustment range helps keep employees working comfortably and ergonomically in all situations.

Adapts to different needs with multiple accessories: swivel arms for screens and document holders, shelves with carton dividers, lights, castors, perforated back panels, bins etc.

TED Electric Desk

Size W x D mm	Module	Max load kg	Code	Code ESD
900 x 800	M750	200	TED809-41	TED809-49
1100 x 800	M900	200	TED811-41	TED811-49
1500 x 800	M1350	200	TED815-41	TED815-49
1800 x 800	M1500	200	TED818-41	TED818-49

Upright Tube Pair with a flange

Size W x D x H mm	Code ESD
70 x 100 x 418	TTP400-49
70 x 100 x 793	TTP790-49
70 x 100 x 997	TTP990-49

Treston upright tubes enable TED electric desk to be accessorised in many ways. Fitted on worktop with screws.



Lower shelf for TED desk

Size W x D mm	Suitable for	Max load kg	Code
465 x 400	All TED benches	60	LST500-49
715 x 400	TED811, TED,815, TED818	60	LST750-49
865 x 400	TED815, TED818	60	LST900-49
965 x 400	TED815, TED818	60	LST1000-49
1165 x 400	TED818	60	LST1200-49
1315 x 400	TED818	60	LST1350-49
Divider hoops set (4 pcs) 400 x 400			PDH400-49

400 mm deep lower shelf for many purposes. Includes back lip. Fitted under worktop with screws. The lower shelf can also be equipped with divider hoops.

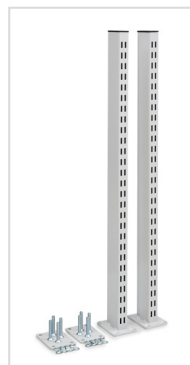

TED packing station example



+

Accessories on pages 18-32

See additional accessories, lighting units, paper roll holders and cutters.

The TED desk can be equipped with castors!



Castor set Ø100 ESD Code LCS100 ESD

Castor set Ø100 Code LCS100

Always adjust the bench with castors to the lowest position when the bench is moved.

Qty	Name	Size mm	Code
1	Treston Electric Desk	1800 x 800	TED818-41
1	Upright Tube Pair with a flange	790	TTP790-49
1	Paper roll holder set for upright tube	Max roll length 1400 mm	859 041-49P
1	Pair of paper roll dividers		RD25
1	Cutter	1350 x 130 x 200	PPC135
1	Steel shelf M1500	1490 x 300	890 756-49
3	Divider pair	285 x 190	010 004-49
1	Light and balancer rail 2 x M750	1500	918 49 006P
1	Treston NaturLite LED	1180	TNL1200
1	Rotating tool frame, double arm	513 x 320	880 865-49P
1	Perforated panel	470 x 300	860 951-49
1	Recycling material bin	530 x 280 x 585	PRMB
1	Tool holder box	400 x 300 x 150	PPH TXL

Treston Quick Edge workstation

Quickest height adjustment on the market



- ✓ The quickest height adjustment on the market - no electricity needed
- ✓ Patent pending solution: Adjust the optimal height effortlessly for every task / produced item
- ✓ Equip with M1200 wide accessories, swivel arms or printer platforms.

The easier the workstation's height adjustment gets, the more likely you will adjust it. Meet the industrial workstation with the quickest height adjustment on the market. Workstation height is adjusted with a completely new, innovative, and user-friendly mechanism. The patent pending height adjustment solution minimises the height exchange time between handled items and makes daily work more fluent, efficient, and ergonomic.

This industrial workstation is designed, for example, for packing and logistic centres, where the desk height adjustment is done according to the differently sized cartons. The Treston Quick Edge Workstation adapts for operators of different standing heights and increases both performance and ergonomics.

Quick Edge workstation

Size W x D mm	Module	Max load kg	Code
1200 x 700	M1200	100*	TQEW712-41

Static load capacity for bench top 100 kg, total load capacity for frame 300 kg.

Spring set for Treston Quick Edge Workstation

Name	Code
Spring set for Treston Quick Edge Workstation	TQES

Replace the constant force spring set at least after every 10 000 operating cycles.

Grounding set for Treston Quick Edge workstation

Name	Code
Grounding set for Treston Quick Edge workstation	TQE-ESD

With this grounding set you can use Treston Quick Edge workstation in EPAs.



Treston Quick Edge packing station example



+ **Accessories on pages 18-32**
See additional accessories, lighting units, paper roll holders and cutters.



Quick Edge workstation can be equipped with castors.

Castor set Ø100 Code LCS100
Castor set ESD Ø 100 Code LCS100 ESD

Qty	Name	Size mm	Code
1	Quick Edge workstation	1200 x 700	TQEW712-41
1	Light and balancer rail M1200	1200	918 49 010P
1	Treston NaturLite LED 1200	1180	TNL1200
1	Shelf for packing material M1200	1167 x 600	SPM1200-49
1	SPM shelf brackets for Treston Quick Edge	12 x 398	SPMTQE-49
1	Divider hoops set (4 pcs)	400 x 280	PDH600-49
1	LCD holder with double arm		930 49 002P
1	Printer platform slideable	315 x 530	859 060-49
1	Rotating tool panel frame, double arm	513 x 320	880 865-49P
1	Perforated panel	470 x 300	860 951-49
1	Aluminium bin rail M500	486 x 55 x 75	BP500C
2	Auxiliary steel shelf	159 x 254 x 50	ASSA5
1	Basic label dispenser	214 x 128 x 120	BLD20
1	Fixed tape dispenser		FTD50
1	Equipment tray	500 x 250 x 125	928 49 002P
1	Roll holder set M1200	Max roll length 1080 mm	890 598-49P
1	Paper roll dividers		RD25



The new, innovative, patent pending height adjustment solution minimises the height exchange time between handled items and makes daily work more fluent, efficient, and ergonomic. Bench top is adjusted without load due to the constant force springs as an adjustment mechanism.

Accessories for Concept, QuatreX, TED and Quick Edge

Aluminium upright profiles and accessories for QuatreX bench on page 24

Our Concept, QuatreX, TED, and Quick Edge benches can be fitted with the same accessories and they are interchangeable. Upright tubes are the basic element for accessorising our industrial furnishings. Accessories are attached to Concept, QuatreX and TED benches with the aid of upright tubes or a complete, upright tube module. The complete upright tube module includes upright tubes, horizontal profile, and fixing plugs. For the Concept and QuatreX bench, the upright tubes are attached to the rear case of the bench with the fixing plates or screws that are delivered with the bench. For the TED bench, upright tube pair with a flange is fitted on worktop with screws.

Upright tubes for Concept and QuatreX

Name	Size W x D mm	Length (l) mm	Code
Upright tube	30 x 60	500	860 991-49
Upright tube	30 x 60	800	860 142-49
Upright tube	30 x 60	996	860 367-49
Upright tube	30 x 60	1359	860 024-49
Upright tube	30 x 60	1582	860 025-49
Horizontal profile	M500		HPM500-49
Horizontal profile	M750		HPM750-49
Horizontal profile	M900		HPM900-49
Horizontal profile	M1000		HPM1000-49
Horizontal profile	M1200		HPM1200-49
Horizontal profile	M1350		HPM1350-49
Horizontal profile	M1500		HPM1500-49
Horizontal profile	M1800		HPM1800-49
Horizontal profile	M2000		HPM2000-49
Fixing plug set (2 pcs)			FPSET

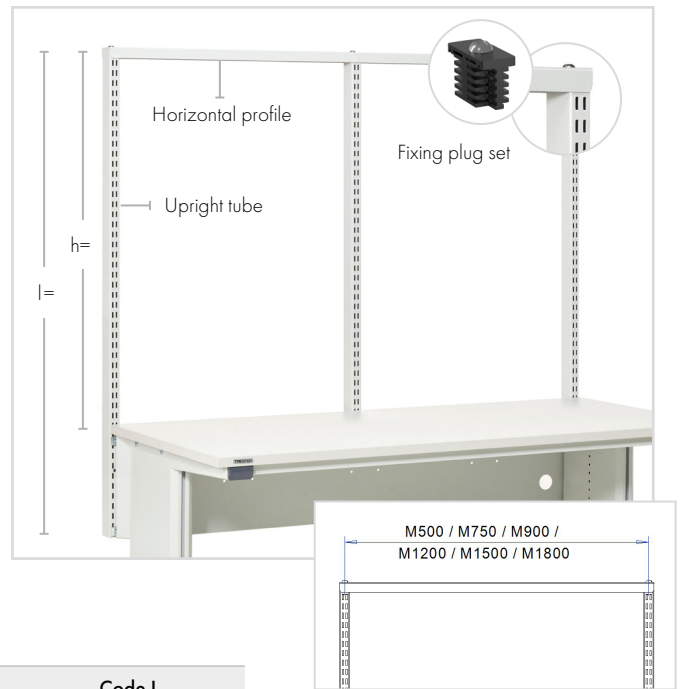

Upright tube modules and compatibility

	Suitable for bench widths C = Concept, Q = QuatreX					Code S	Code M	Code L
	1000	1200	1500	1800	2000	l=996 mm h=683 mm*	l=1359 mm h=1046 mm*	l=1582 mm h=1269 mm*
1 x M750	C	C	C	C	C	UTM1X750S-49	UTM1X750M-49	UTM1X750L-49
1 x M900	C	C	C	C	C	UTM1X900S-49	UTM1X900M-49	UTM1X900L-49
1 x M1200		C/Q				-	UTM1X1200M-49	-
1 x M1500			C/Q	C	C	-	UTM1X1500M-49	-
1 x M1800				C/Q	C/Q	-	UTM1X1800M-49	-
2 x M500	C/Q	C				UTM2X500S-49	UTM2X500M-49	UTM2X500L-49
2 x M750			C/Q	C	C	UTM2X750S-49	UTM2X750M-49	UTM2X750L-49
2 x M900				C/Q	C/Q	UTM2X900S-49	UTM2X900M-49	UTM2X900L-49
3 x M500			C/Q	C		UTM3X500S-49	UTM3X500M-49	UTM3X500L-49
4 x M500					C/Q	UTM4X500S-49	UTM4X500M-49	UTM4X500L-49

*h = module's height measured from bench's top surface.

Load capacity 100 kg / module spacing. With QuatreX the total load capacity of the upright structure is 150 kg.

Upright tube module includes upright tubes, horizontal profile, fixing plugs, and 5 pcs of cable clips for easy cable management.

The modular (M) size refers to the distance between two upright tubes from the middle of the tube. The modular size is used to find the appropriate accessories.

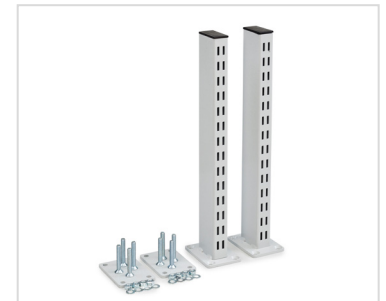

Upright tube pair with a flange for TED

Upright tube pair with a flange for TED

Size W x D x H mm	Code
70 x 100 x 418	TTP400-49
70 x 100 x 793	TTP790-49
70 x 100 x 997	TTP990-49

Load capacity 80 kg.

Aluminium bracket

Name	Code
Aluminium bracket	846 554-00

A separate aluminium bracket can be used to attach a single tube to any bench.



Aluminium bracket

Light and balancer rail (includes one sliding piece)

Module	Width of the front profile mm	Max load kg	Code
2 x M500	1000	15	918 49 001P
2 x M500/1500	1500	15	918 49 002P
4 x M500	2000	15	918 49 003P
M750	750	15	918 49 004P
M750/900	900	15	918 49 013P
M750/1500	1500	15	918 49 005P
2 x M750	1500	15	918 49 006P
3 x M750	2250	15	918 49 012P
M900	900	15	918 49 007P
2 x M900	1800	15	918 49 008P
M900/1500	1500	15	918 49 009P
M1200	1200	15	918 49 010P
M1350	1350	15	918 49 011P

Luminaires are fitted to light/balancer rails which are height and depth adjustable.



Light and balancer rail

Tiltable top shelf TTS

Module	Size W x D mm	Max load kg	Code
M500	467 x 300	80	TTSM5003-49
M500	467 x 400	80	TTSM5004-49
M750	717 x 300	80	TTSM7503-49
M750	717 x 400	80	TTSM7504-49
M900	870 x 300	80	TTSM9003-49
M900	870 x 400	80	TTSM9004-49
M1000	967 x 300	80	TTSM10003-49
M1000	967 x 400	80	TTSM10004-49
M1200	1167 x 300	80	TTSM12003-49
M1200	1167 x 400	80	TTSM12004-49
M1350	1320 x 300	80	TTSM13503-49
M1350	1320 x 400	80	TTSM13504-49
M1500	1467 x 300	80	TTSM15003-49
M1500	1467 x 400	80	TTSM15004-49
M1800	1773 x 300	80	TTSM18003-49
M1800	1773 x 400	80	TTSM18004-49
M2000	1973 x 300	80	TTSM20003-49
M2000	1973 x 400	80	TTSM20004-49

Max. tilt 20 degrees (depth 300 mm) or 12,5 degrees (depth 400 mm). Front lip height 30 mm. Can also be installed at the back of the shelf.



Tiltable top shelf M500, M750, M900, M1000, M1200, M1350, M1500, M1800, M2000

Divider hoops set (4 pcs)

Suitable for	Size D x H mm	Code
Tiltable top shelf TTS depth 300 mm	300 x 400	PDH300-49
Tiltable top shelf TTS depth 400 mm	400 x 400	PDH400-49



Divider hoops set (4 pcs)

Divider pair

Suitable for	Size D x H mm	Code
Tiltable top shelf TTS depth 300 mm	285 x 190	861 116-49
Tiltable top shelf TTS depth 400 mm	385 x 190	861 118-49



Divider pair

Shelf for packing material SPM

Name	Size W x D x H mm	Max load kg	Suitable for	Code
Shelf for packing material	467 x 600 x 32	60	M500	SPM500-49
Shelf for packing material	717 x 600 x 32	60	M750	SPM750-49
Shelf for packing material	870 x 600 x 32	60	M900	SPM900-49
Shelf for packing material	1167 x 600 x 32	60	M1200	SPM1200-49
Shelf for packing material	1317 x 600 x 32	60	M1350	SPM1350-49
Shelf for packing material	1467 x 600 x 32	60	M1500	SPM1500-49
Shelf for packing material	1773 x 600 x 32	60	M1800	SPM1800-49
Brackets for Concept accessory bar			SPM-shelves	SPMH-49
Adjustable fastening set under worktop	90 x 350 x 355 (free space 285-465 on lower shelf)		SPM-shelves	SPMAF-49
Brackets for upright tube			SPM-shelves	SPMBS-49
Brackets for Treston Quick Edge	398 x 12 x 105		SPM-shelves	SPMTQE-49
Divider hoops set (4 pcs)	8 x 400 x 280		SPM-shelves	PDH600-49

The shelf does not include fastening parts.

SPM shelves aren't suitable for TED electric desk. Lower shelves for TED on page 14.



Shelf for packing material and brackets for Concept accessory bar



Shelf for packing material, adjustable fastening set under worktop and divider hoops

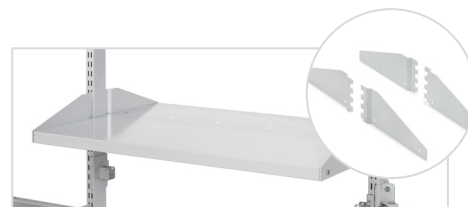

Shelf for packing material and brackets for upright tube

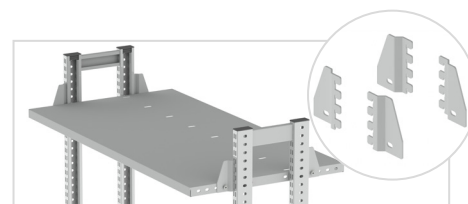

Shelf for packing material and brackets for Treston Quick Edge



Roll holder set and paper roll divider



Roll holder set under worktop



Packing material holder for upright tubes

Suitability of lower shelves to 750 and 900 mm deep benches

Concept 2000/1800: SPM1500 or smaller	QuatreX 2025: SPM1800 or smaller
Concept 1500: SPM1200 or smaller	QuatreX 1825: SPM1500 or smaller
Concept 1200: SPM900 or smaller	QuatreX 1525: SPM1200 or smaller
Concept 1000: SPM500	QuatreX 1225: SPM900 or smaller
	QuatreX 1025: SPM750 or smaller

SPM-shelves are fixed to Treston QuatreX with SPMAF-49 brackets.

Roll holders

Name	Max roll length mm	Max load kg	Suitable for	Code
Roll holder set	635	40	M750	890 547-49P
Roll holder set	785	40	M900	890 548-49P
Roll holder set	1080	40	M1200	890 598-49P
Roll holder set	1400	40	M1500	859 041-49P
Roll holder set	1700	40	M1800	859 042-49P
Roll holder set under worktop 1500*	1200	40	M1500	859 044-49P
Roll holder set under worktop 1800*	1500	40	M1800	859 045-49P
Paper roll dividers (2 pcs) Ø 170 mm				RD25

* Suitable only for the Concept bench.

Packing material holders

Name	Max width of material mm	Suitable for	Code
Packing material holder for upright tubes	635	M750	PMH750-49
Packing material holder for upright tubes	785	M900	PMH900-49
Packing material holder for upright tubes	1080	M1200	PMH1200-49
Packing material holder for upright tubes	1200	M1350	PMH1350-49
Packing material holder for upright tubes	1400	M1500	PMH1500-49
Packing material holder for upright tubes	1700	M1800	PMH1800-49

Handy holder for packing material that can be taken from a roll. Holds material in place during and after cutting. Can hold two different materials at the same time.

Cutting support for packing material holder

Name	Suitable for	Code
Cutting support for packing material holder	PMH750-49	CSM750-49
Cutting support for packing material holder	PMH900-49	CSM900-49
Cutting support for packing material holder	PMH1200-49	CSM1200-49
Cutting support for packing material holder	PMH1350-49	CSM1350-49
Cutting support for packing material holder	PMH1500-49	CSM1500-49
Cutting support for packing material holder	PMH1800-49	CSM1800-49

Pull-out, ergonomic cutting support for packing material. The support helps to cut packing material more easily e.g. with a carpet knife. Attached to the PMH packing material holder. Distance from the upright tube 250-400 mm. Pull-out distance 150 mm.

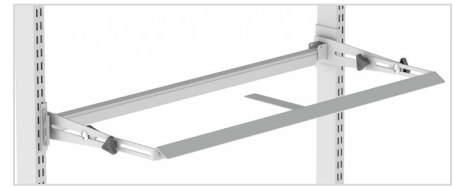

Cutting support for packing material holder

Pull-out steel shelf for printer

Name	Size W x D x H mm	Max load kg	Suitable for	Code
Pull-out steel shelf for printer	500 x 510 x 515	35	Concept, TPB	PSP50

Mounting under the bench top. Free space for printer 400 x 500 x 415 mm. Pull-out extent 500 mm. Suitable for 750 and 900 deep Concept benches.



Pull-out steel shelf for printer

Printer platform slideable

Name	Size W x D x H mm	Max load kg	Suitable for	Code
Printer platform slideable	315 x 530	30	Concept, TED	859 060-49

Printer shelf with sliding platform for easy replacement of the label roll. Mount on upright tube.



Printer platform slideable

Recycling material bin

Name	Size W x D x H mm	Max load kg	Suitable for	Code
Pull-out recycling material bin	286 x 570 x 650	15	Concept, TPB	PRMB3
Recycling material bin	280 x 530 x 585	15	TED	PRMB
Recycling material bin	286 x 570 x 650	15	QuatreX	PRMBQX



PRMB3 PRMB PRMBQX

Recycling material bins

Tool tray PTH

Name	Size W x D mm	Suitable for	Code
Tool tray PTH	1000 x 60	Concept motor benches, QuatreX, TED	PTH100



Tool tray PTH

Equipment tray

Name	Size W x D mm	Max load kg	Code
Equipment tray	250 x 250 x 90	10	928 49 001P
Equipment tray	500 x 250 x 125	15	928 49 002P
Equipment tray *	500 x 250 x 125	30	928 49 003P

* Comes with heavy arm.



Equipment tray

Document shelf

Name	Module	Size W x D mm	Max load kg	Code
Document shelf	M500	470 x 265	5	860 806-49
Document shelf	M750	720 x 265	5	860 115-49
Document shelf	M900	870 x 265	5	860 399-49

Handy steel document shelf (tilting 10-75°) for plastic bins, papers, small tools, etc.

Document shelf, tilting 10 - 75°
Adjustable auxiliary shelf

Name	Size W x D mm	Tilting	Max load kg	Code	Code ESD
Adjustable auxiliary shelf	560 x 340	0-25°	15	927 41 001P	927 49 001P
Adjustable auxiliary shelf	605 x 405	0-25°	15	927 41 002P	927 49 002P

Ergonomic tilt adjustable tray with double arm (0-25°). Lipped edge of 15 mm.

Adjustable auxiliary shelf
Auxiliary top, fixed brackets

Name	Size W x D mm	Max load kg	Code	Code ESD
Auxiliary top left	400 x 500	40	926 41 001P	926 49 001P
Auxiliary top right	400 x 500	40	926 41 002P	926 49 002P

Suitable for printer, boxes, etc. Mount on upright tube.

Auxiliary top
Document holders

Name	Size W x D mm	Max load kg	Code
Document holder A4	290 x 330	5	928 49 008P
Document holder A3	418 x 330	5	928 49 009P

Steel document holder fixed on upright tube. Easily adjustable with the double arm.

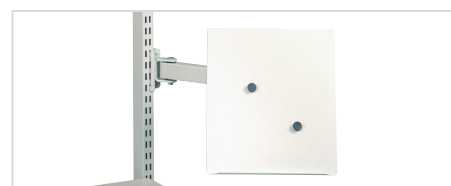
Document holder
LCD monitor holder for perforated panel

Name	Max load kg	Code
LCD monitor holder for perforated panel	10	890 715-49

Suitable for VESA 75/100

LCD monitor holder for perforated panel

PC/folder box
PC/folder box

Name	Size W x D x H mm	Max load kg	Code
PC/folder box, fitted to the upright tubes	130 x 290 x 330	5	860 983-49

LCD holder with double arm

Name	Size W x D x H mm	Max load kg	Code
LCD holder with double arm*		15	930 49 002P
Keyboard tray for LCD holder	480 x 260	5	860 941-49
Keyboard and mouse tray for LCD holder	620 x 260	5	860 942-49

Fixed to keyboard tray 860941-49 or 860942-49.

* Suitable for VESA 75/100

LCD-holder and keyboard tray

LCD holder with double arm

Aluminium bin rail

Name	Module	Size W x D mm	Max load kg	Code
Aluminium bin rail	M500	486 x 55 x 75	40	BP500C
Aluminium bin rail	M750	736 x 55 x 75	40	BP750C
Aluminium bin rail	M900	889 x 55 x 75	40	BP900C
Aluminium bin rail	M1350	1320 x 55 x 75	40	BP1350C
Aluminium bin rail	M1500	1486 x 55 x 75	40	BP1500C
Aluminium bin rail	M1800	1792 x 55 x 75	40	BP1800C

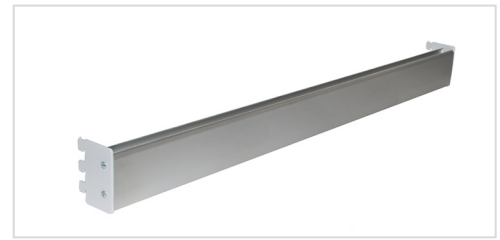

Aluminium bin rail BP

Perforated back panel

Name	Module	Size W x H mm	Code
Perforated back panel	M500	468 x 389	861 501-49
Perforated back panel	M750	718 x 194	861 510-07
Perforated back panel	M750	718 x 389	861 511-49
Perforated back panel	M750	718 x 612	861 512-07/-49
Perforated back panel, insulated	M750	718 x 612	861 701-07/-49
Perforated back panel	M750	718 x 1003	861 514-07/-49
Perforated back panel	M900	871 x 389	861 516-49
Perforated back panel	M900	871 x 612	861 517-07/49
Perforated back panel	M900	871 x 1003	861 519-07/49
Perforated back panel	M1000	968 x 389	861 532-49
Perforated back panel	M1000	968 x 612	861 538-07/49
Perforated back panel	M1000	968 x 1003	861 535-07
Perforated back panel	M1200	1168 x 389	861 533-49
Perforated back panel	M1350	1318 x 389	861 521-49
Perforated back panel	M1500	1474 x 389	861 526-49
Perforated back panel	M1800	1774 x 389	861 531-49

Fastened to the upright tubes.

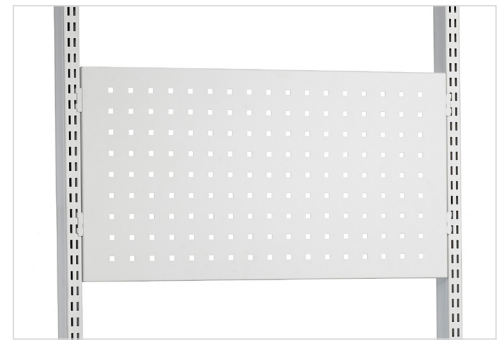

Perforated back panel

Rotating tool frame

Name	Size W x D mm	Max load kg	Code
Rotating tool panel frame, height-adjustable arm	513 x 320	15	860 864-49P
Rotating tool panel frame, double arm	513 x 320	15	880 865-49P



Rotating tool panel frame, height-adjustable arm

Accessories for rotating tool frame

Name	Size W x D mm	Max load kg	Code
Perforated panel	470 x 300		860 951-49
Tool trough M500	470 x 150		860 952-49
Bin rail M500	492 x 90	15*	859 150-49
Light bin rail M500	492 x 54	10	860 953-49
Aluminium bin rail M500 for rotating tool panel	486 x 55 x 75	15	BP500C
Auxiliary steel shelf	217 x 298 x 20	3	ASSA4
Auxiliary steel shelf	159 x 254 x 50	2	ASSA5

*Actual bin rail max load 40 kg but with arm 15 kg.



Rotating tool panel frame with M500 perforated panel, aluminium bin rail M500 and auxiliary steel shelf

Bottle holder

Name	Code
Bottle holder (Ø 100) for upright tube	859 063-49



Bottle holder

Accessories for QuatreX

Upright profiles for Treston QuatreX

Size W x H mm	Suitable for bench widths	Code
1060 x 1200	1025*, 1225	AL2X110QX
1489 x 1200	1525	AL2X150QX
1789 x 1200	1825, 2025	AL2X180QX

Needed for mounting aluminium accessories to the Treston QuatreX bench. Includes 2 vertical and 1 horizontal profile. With 3 cable clips (CC8). Load capacity 150 kg/AL2X.

*without horizontal profile



Upright profiles AL2XQX

Accessory frame AKK

Size W x D mm	Suitable for	Code
730 x 540	AL2X110QX AL2X150QX AL2X180QX	AKK70
690 x 500 + 690 x 500	AL2X150QX	AKK150
690 x 500 + 990 x 500	AL2X180QX	AKK180

Divides the space between the upright profiles into 2 modules. AKK frame includes 1 vertical and 1 horizontal profile. Useable height 500 mm.



Accessory frame AKK

Support bracket HSB

Length mm	Suitable for	Code
1073	AL2X110QX	HSB110
1500	AL2X150QX	HSB150
1800	AL2X180QX	HSB180

Support bracket of steel for suspending power tools and lighting units. Mount on upright profiles.



Support bracket HSB

Shelf ALH

Size W x D mm	Suitable for	Code	Code ESD
1073 x 310	AL2X110QX, combination AL2X180QX + AKK180	ALH110	ALH110 ESD
1500 x 310	AL2X150QX	ALH150	ALH150 ESD
1800 x 310	AL2X180QX	ALH180	ALH180 ESD

Height adjustable shelf. 25 mm laminated particle board. Load capacity 50 kg. Mount on upright profiles.



Shelf ALH

Divider hoops PDH

Height mm	Suitable for	Code
400	ALH	PDH

Used in combination with shelf ALH. Comes in sets of 5.



Divider hoops PDH

Backstop LIST

Size W x D x H mm	Suitable for	Code	Code ESD
1400 x 52 x 27	ALH150, ALH 150 ESD	LIST150	LIST150
1700 x 52 x 27	ALH180, ALH180 ESD	LIST180	LIST180

Prevents items from falling off the shelf. Can be fixed on the lower shelf AT or on the shelf ALH.

**Backstop LIST****Adjustable shelf ASH**

Size W x D mm	Suitable for	Code	Code ESD
660 x 400	AKK70, AKK150, AKK180	ASH70	ASH70 ESD
960 x 400	AKK180, AL2X110GX	ASH100	ASH100 ESD

Continuous adjustment for depth, height and angle. Shelf of 25 mm laminated particle board. Lipped front edge. Load capacity 35 kg static load. Mount on accessory frame AKK.

**Adjustable shelf ASH****Swivel arm with tray AKV**

Size W x D mm	Suitable for	Code	Code ESD
460 x 210 (tray)	AL2X upright profiles	AKV400	AKV400 ESD

Angle adjustable steel tray with swivel radius of 360°. Length of swivel arm 590 mm. Max. load 15 kg.

**Swivel arm with tray AKV****Component rack EPL**

Size W x D x H mm	Suitable for	Shelves number	Code	Code ESD
455 x 200 x 290	AKV	3	EPL12	ESD

Rack with three fixed shelves. Semiconductive epoxy powder coated steel in light grey (RAL 7035). Bins ordered separately, page 50. Component rack holds: 12 stacking bins 1015-4ESD or 12 picking bins 30-1L-4ESD or 6 picking bins 30-2L-4ESD or 6 picking bins 30-23L-4ESD.

**Component rack EPL****Keyboard shelf WKA**

Size W x D mm	Suitable for	Code	Code ESD
500 x 220 (shelf)	AL2X upright profiles	WKA	WKA ESD

Keyboard shelf with swivel arm. Epoxy powder coated steel. Load capacity 15 kg. Arm length 220 mm.

**Keyboard shelf WKA****Document stand WDA**

Size W x H mm	Suitable for	Code	Code ESD
440 x 300	AL2X upright profiles	WDA	WDA ESD

Document stand A3 with swivel arm. Epoxy powder coated steel: light grey. Arm length 220 mm. Tilt 75°.

**Document stand WDA**

Perforated panel ARL

Size W x H mm	Suitable for	Code	Code ESD
668 x 500	AKK70, AKK150	ARL70	ARL70
968 x 500	AKK180, AL2X110QX	ARL100	ARL100

Mount on accessory frame AKK. The size of the perforation is 9 x 9 mm, center to center 38 mm.

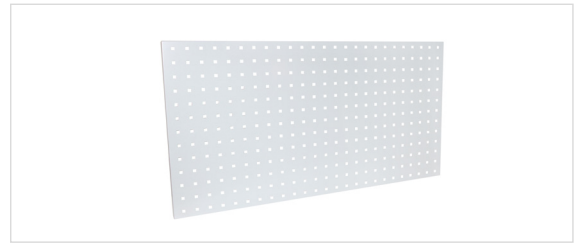

Perforated panel ARL

Bin profile BP

Length mm	Suitable for	Code	Code ESD
685	AKK 70, AKK150, AKK180	BP70	BP70 ESD
985	AKK180, AL2X110QX	BP100	BP100 ESD

Aluminium profile for stacking and picking bins. Mount on accessory frame AKK.



Bin profile BP

Recycling material bin PRMBX

Size W x D x H mm	Suitable for	Code
286 x 570 x 650	QuatreX	PRMBQX

The 60 ltr bin with steel brackets has a maximum load of 15 kg and can be positioned on either side of the bench.

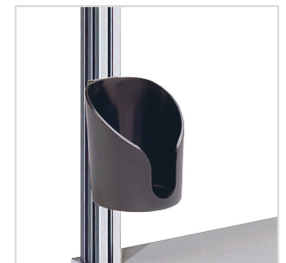

Recycling material bin PRMBX

Bottle holder CH

Bottle holder CH

Size W x D x H mm	Ø mm	Suitable for	Code
110 x 105 x 120	80	AL2X upright profiles	CH

Practical holder for bottle or cup. Made of black polypropylene.

Tool tray PTH

Size W x D mm	Suitable for	Code
1000 x 60	QuatreX, TED, Concept motor benches	PTH100

The tool tray guarantees a clean working space, while tools are close to hand.



Tool tray PTH

Cable clip set CC

Set	Suitable for	Code
5 pieces	AL2X upright profiles	CC8

The cable clip set will hold cables etc. securely and neatly in place along the bench frame. The clips locate in the 8 mm profile slot.

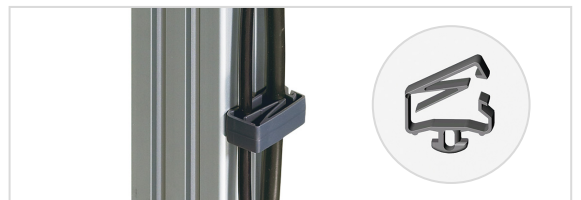

Cable clip set CC

Arm adapters for Concept, QuatreX, TED and Quick Edge accessories with arms

Profile type	Workbench / trolley model	40 mm arm	60 mm arm
AL2X aluminium profiles	QuatreX	890 524-49	890 525-49

Arm accessories for upright tubes can be used in other profile types with adapters.

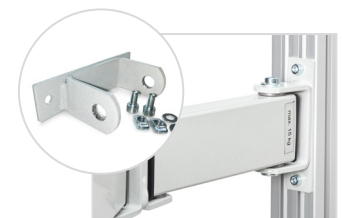

Accessories for TPB

Tool and lighting support KT

	Size W x D mm	Suitable for	Code
	1500 x 600	TPB915	KT150
	1800 x 600	TPB918	KT180
Extra C-profile	1500	KT150	SPR150
Extra C-profile	1800	KT180	SPR180

For suspending power tools and lighting units. Includes one C-profile bar with sliding hook.



Tool and lighting support KT

Upright profiles HKCP

Height mm	Suitable for	Code
1470	TPB	HKCP147

If you need more space for uprights. 400 mm taller than standard one.



Upright profiles HKCP

Lower steel shelf LSS

Name	Size W x D mm	Max load kg	Code
Lower shelf	1418 x 460	30	LSS150
Lower shelf	1718 x 460	30	LSS180
Low M-divider hoops (4 pcs/set)	460 x 315		LDH

Hangs on the horizontal bars. Can be equipped with steplessly adjustable low M-divider hoops.



Lower steel shelf LSS

Shelf for packing material SPM

Size W x D x H mm	Max load kg	Code
467 x 600 x 32	60	SPM500-49
717 x 600 x 32	60	SPM750-49
870 x 600 x 32	60	SPM900-49
1167 x 600 x 32	60	SPM1200-49
1317 x 600 x 32	60	SPM1350-49
1467 x 600 x 32	60	SPM1500-49

The shelf does not include fastening parts.



Shelf for packing material, adjustable fastening set under worktop and divider hoops

Adjustable fastening set under worktop

Size W x D x H mm	Suitable for	Code
90 x 350 x 355	SPM-shelves	SPMAF-49

Free space 285-465 mm on lower shelf.



Adjustable fastening set under worktop

Side worktop

Size W x D mm	Max load kg	Code
400 x 900	35	TP904 ST

Easy to fix to the legs of the bench. Can be fixed on the left or right side of the bench and brackets placed either above or underneath. Height adjustable 575-900 mm from the floor.



Side worktop

Pull-out steel shelf for printer

Size W x D x H mm	Max load kg	Suitable for	Code
500 x 510 x 515	35	Concept, TPB	PSP50

Mounting under the bench top. Free space for printer 400 x 500 x 415 mm. Pull-out extent 500 mm.



Pull-out steel shelf for printer

Divider hoops PDH

Height mm	Code
400	PDH

Adjustable divider hoops for shelf of depth 310 mm. 5 pcs per set. Included in the TPB packing bench; also available as an accessory.



Divider hoops PDH

Swivel arm with tray CKV

Size W x D mm	Max load kg	Code	Code ESD
Tray 460 x 210	15	CKV400	CKV400 ESD

Swivel arm with lockable, angle adjustable steel tray. Mount on C-profile.



Swivel arm with tray CKV

Recycling material bin

Name	Size W x D x H mm	Max load kg	Code
Pull-out recycling material bin	286 x 570 x 650	15	PRMB3
Recycling material bin	280 x 530 x 585	15	PRMB



Recycling material bin PRMB3



Recycling material bin PRMB

Bin profile BP

Width mm	Max load kg	Suitable for	Code	Code ESD
1415	15	TPB915	BP150	BP150 ESD
1715	15	TPB918	BP180	BP180 ESD



Bin profile BP

LCD swivel arm MA

Max load kg	Suitable for	Code
10	TPB+ AS2	MA

The quick-release mechanism is equipped with the standard flat-screen mount 75 x 75 and 100 x 100 for the mounting of all normal flat-screens. The arm is double articulated, turns through a radius of 180° and will extend between 95-425 mm from the upright.

Adapter set AS2 is needed for mounting LCD swivel arm MA to TPH benches, ordered separately.

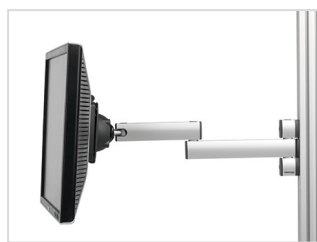

LCD swivel arm MA



Adapter set AS2

Adapter set AS

Suitable for	Code
LCD swivel arm MA	AS2

Cable clip set CC

Set	Max load kg	Code
5 pcs/set	15	CC 12

The cable clip set will hold cables etc. securely and neatly in place along the bench frame. The clips locate in the 12 mm profile slot.



Cable clip set CC



Accessories for all packing benches

Auxiliary steel shelf ASSA

Size W x D x H mm	Suitable for	Code
217 x 330 x 50	Bin rails	ASSA4
159 x 254 x 50	Bin rails	ASSA5

Shelf for A4/A5 paper and tape dispensers (max 2 pcs per shelf). Mounted on bin profile. Max load 3 kg.



Auxiliary steel shelf ASSA

Auxiliary steel shelf for perforated panel

Size W x D x H mm	Suitable for	Code
159 x 243 x 56	Perforated panels	ASSA5PP

Auxiliary steel shelf for A5 documents, tape dispenser or handheld scanner. Attached to the perforated panel.



Auxiliary steel shelf for perforated panel

Fixed tape dispenser

Suitable for	Code
ASSA4	FTD50

Includes screws to fix the dispenser to ASSA4. Max roll Ø 120 mm and width 50 mm.



Fixed tape dispenser



Basic label dispenser

Basic label dispenser

Size W x D x H mm	Suitable for	Code
214 x 128 x 120	ASSA4	BLD20

Can be fixed with screws to ASSA4. Max roll Ø 220 mm and width 210 mm.

Tool holder box PPH

Size W x D x H mm	Suitable for	Code
400 x 300 x 140	Concept, TPB, TED, Quick Edge	PPH TXL

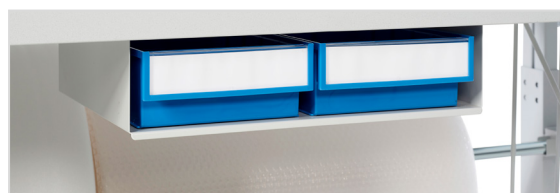

Tool holder box PPH

Stacking bin set SBS4

Size W x D x H mm	Suitable for	Code
2 pcs 230 x 155 x 140	Bin rails	SBS4
2 pcs 185 x 125 x 115		

Four bins made of blue polypropylene (PP).



Stacking bin set SBS4

Paper roll holder

Width mm	Suitable for	Code
300	Perforated panels	854 043-49

Max roll width 300 mm.

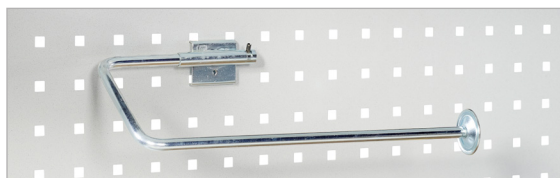

Paper roll holder



Stacking bins

Labels and cross dividers

No.	Capacity l	Outer dims W x D x H mm	Inner dims W x D x H mm	Pack pcs	Code * blue	Code * red	Code * ESD black	Labels + shields	Pack min. order	Cross divider	Pack pcs
1.	0,6	105 x 165 x 75	90 x 105 x 65	60	1015-6	1015-5	1015-4 ESD	E10	60		
2.	2,7	149 x 250 x 130	125 x 185 x 115	30	1525-6	1525-5	1525-4 ESD	E15	30	V-14	30
3.	5,0	186 x 300 x 156	155 x 230 x 140	24	1930-6	1930-5	1930-4 ESD	E20	24	V-19	24
4.	7,2	186 x 400 x 156	155 x 330 x 140	24	1940-6	1940-5	1940-4 ESD	E20	24	V-19	24
5.	1,1	99 x 160 x 70	85 x 100 x 62	60	30-1L-6		30-1L-4 ESD				
6.	2,2	198 x 160 x 70	175 x 100 x 62	30	30-2L-6		30-2L-4 ESD				
7.	2,2	198 x 160 x 70	175 x 100 x 62 (2 fixed length dividers)	30	30-23L-6		30-23L-4 ESD				

*) Order number/one item. All bins are also available in grey colour, colour code -3



Shelf bins

Cross dividers

No.	Capacity l	Outer dims W x D x H mm	Inner dims W x D x H mm	Pack pcs	Code* blue	Code * red	Code * ESD black	Code*	Number/bin
1.	1,9	92 x 400 x 82	75 x 357 x 70	30	4010-6	4010-5	4010-4 ESD	D-10	6
2.	2,4	92 x 500 x 82	75 x 457 x 70	30	5010-6	5010-5	5010-4 ESD	D-10	8
3.	4,2	186 x 400 x 82	167 x 357 x 70	15	4020-6	4020-5	4020-4 ESD	D-20	6
4.	5,3	186 x 500 x 82	167 x 457 x 70	15	5020-6	5020-5	5020-4 ESD	D-20	8
5.	6,5	186 x 600 x 82	167 x 557 x 70	15	6020-6	6020-5	6020-4 ESD	D-20	10

*) Order number/one items. All bins are also available in grey colour, colour code -3

Lighting

Name		Size W x D x H mm	Suitable for	Code
Treston NaturLite LED 1200	Lean aluminium body, dimmable bright light, max 3100 lx, 56 W, 4000 K, opal cover.	1180 x 120 x 50	Concept, QuatreX, TPB, TED, Quick Edge	TNL1200
Treston NaturLite LED 900	Lean aluminium body, dimmable bright light, max 2300 lx, 42 W, 4000 K, opal cover.	900 x 120 x 50	Concept, QuatreX, TPB, TED, Quick Edge	TNL900
Treston NaturLite LED Wing 500	Sidelight. Lean aluminium body, dimmable, max 800 lx, 14W, 4000 K, opal cover.	430 x 120 x 50 mm (+ bracket 95/120 mm)	Concept, QuatreX, TPB*, TED, Quick Edge	TNL500W

*TPB benches require bracket 890 683-49

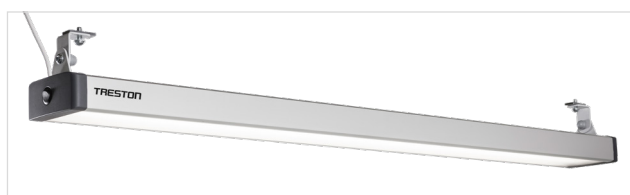

Treston NaturLite LED 1200



Treston NaturLite LED 900



Treston NaturLite LED Wing 500

Packing material roll stands

1. High packing material roll stand

High stand for two rolls. The rolls are adjustable in height. Axle diameter 25 mm. Max roll Ø 800 mm. Can be equipped with extra roll holder set, castor set and cutter PPC. Max load 40 kg per roll.

Size W x D x H mm	Module	Max roll width mm	Code
1380 x 764 x 1640	M1350	1200	890 520-49P
1530 x 764 x 1640	M1500	1400	890 521-49P
1830 x 764 x 1640	M1800	1700	890 522-49P



2. Low packing material roll stand

Low stand for one roll. The roll is adjustable in height. Axle diameter 25 mm. Max roll Ø 800 mm. Can be equipped with extra roll holder set, castor set and cutter PPC. Max load 40 kg per roll.

Size W x D x H mm	Module	Max roll width mm	Code
1380 x 764 x 1000	M1350	1200	859 103-49P
1530 x 764 x 1000	M1500	1400	859 105-49P
1830 x 764 x 1000	M1800	1700	859 108-49P



3. Castor set for packing material roll stands

4 swivel castors Ø 100 mm, 2 with brakes. Attached directly to the stands.

Size mm	Code
Ø 100	LCS100



4. Extra roll holder set

Extra roll holder set for packing material roll stands. Including brackets. Axle diameter 25 mm, zinc electroplated. Max load 40 kg.

Module	Max roll width mm	Code
M1350	1200	859 040-49P
M1500	1400	859 041-49P
M1800	1700	859 042-49P



Cutters

1. Cutter PPC

The round cutting knife will slice through paper and cardboard with ease. Can be affixed to the bench top or alternatively to the upright profiles with fixing brackets PPC FB.

Size W x D x H mm	Module	Cutting width mm	Code
1200 x 130 x 200	M1200	950	PPC120
1350 x 130 x 200	M1350	1110	PPC135
1485 x 130 x 200	M1500	1250	PPC150
1785 x 130 x 200	M1800	1550	PPC180



2. Fixing brackets for cutter

In order to obtain an ergonomic position, the cutters can also be affixed to the upright profiles of all the workbenches using these fixing brackets. The fixing brackets make the cutter both height and tilt adjustable, tilt 30 degrees. Cutter is ordered separately.

Suitability	Code
All benches	PPC FB



3. Bracket pair for cutter

Cutter PPC can be fitted to the packing material roll stand with the bracket pair. Height adjustable. Cutter is ordered separately.

Suitability	Code
Packing material roll stands	890 511-49P



Trolleys

Only a selection of our trolleys is presented in this brochure. Please visit our webpage for the full range.

Low carton trolley LCT610

Trolley for large cartons. Three dividers can be assembled crosswise or lengthwise. The fourth divider is a push handle.

Frame and shelf are of epoxy powder-coated steel in grey RAL 7035. Four swivel castors (Ø 100 mm), two of which have brakes. Shelf height above the ground 160 mm.

Size W x D x H mm	Shelf size W x D mm	Max load kg	Code
1080 x 630 x 1020	1000 x 630	150	LCT610



High carton trolley HCT410

Trolley for packing cartons. Shelves are equipped with steplessly adjustable steel M-divider hoops. Larger hoop height 540 mm, lowest point 330 mm above the shelf, smaller hoop height 315 mm, lowest point 105 mm above the shelf.

Frame and individually height adjustable shelves are of epoxy powder-coated steel in grey RAL 7035. Four swivel castors (Ø 100 mm), two of which have brakes.

Size W x D x H mm	Shelf size W x D mm	Max load kg	Code
1090 x 530 x 1515	1000 x 430	150	HCT410



Carton trolley

Name	Description	Size W x D x H mm	Code
1. Castor Set	Castor set for carton trolley. The castor set gives you a trolley from the SPM-shelf.	600 x 125	SPMCS-41
2. Shelf for packing material	600 mm deep shelf for many purposes. The shelf can also be equipped with PDH600 divider hoops. Max load 60 kg.	467 x 600 x 32	SPM500-49
		717 x 600 x 32	SPM750-49
		870 x 600 x 32	SPM900-49
		1167 x 600 x 32	SPM1200-49
		1317 x 600 x 32	SPM1350-49
		1467 x 600 x 32	SPM1500-49
3. Divider hoops set (4 pcs), SPM-shelf	Divider hoop set for the SPM-shelves. Height 280 mm. The fixed divider is tightened with the screw at the front edge of the shelf.	1773 x 600 x 32	SPM1800-49
		8 x 400 x 280	PDH600-49



Recycling material trolley PRMT

The recycling trolleys are ideal for placing underneath or beside the packing bench. The bins are adjustable in angle for ease of use! The trolley comes with four swivel castors, two with brakes. Available in single and double version.

Size W x D x H mm	Code
350 x 625 x 765	PRMT 1
680 x 625 x 765	PRMT 2



Industrial multi trolley frame with accessories

Name	Description	Module	Size W x D x H mm	Code
1. Industrial multi trolley frame	Max load 300 kg.	M750	790 x 760 x 1790	TMTFH7-41
		M900	943 x 760 x 1790	TMTFH9-41
2. Shelf for packing material	600 mm deep shelf for many purposes. The shelf can also be equipped with PDH600 divider hoops. Max load 60 kg.		717 x 600 x 32	SPM750-49
			870 x 600 x 32	SPM900-49
3. Brackets for upright tube SPM	Mounting parts for top shelf to the upright tube. With the mounting kit, you attach the SPM shelf to the upright tube.			SPMBS-49
4. Divider hoops set SPM-shelf	Divider hoop set (4 pcs) for the SPM-shelves. Height 280 mm. The fixed divider is tightened with the screw at the front edge of the shelf.		8 x 400 x 280	PDH600-49
5. Aluminium bin rail	For auxiliary steel shelf, stacking and picking bins. Very sturdy. Max load 15 kg.	M750	736 x 55 x 75	BP750C
		M900	889 x 55 x 75	BP900C
6. Tablet bracket MY	Tablet bracket for 7-10" tablets.			MY
LCD bracket MH	The quick-release mechanism is equipped with the standard used flat-screen mount 75 x 75 and 100 x 100 for the mounting of all normal flat screens.			MH
Adapter set	Adapter set for fixing LCD bracket MH to the upright tubes.		200 x 110 x 60	AS2
7. Auxiliary steel shelf	Shelf for A4 paper and tape dispensers (max 2 pcs per shelf). Mounted on bin profile. Max load 3 kg.		217 x 298 x 20	ASSA4
8. Roll holder set	Roll holder set for packing material rolls. Max load 40 kg.	M750		890 547-49P
		M900		890 548-49P
9. Fixed tape dispenser	Feeds tape from a roll; for a tape roll with a 76-mm socket. Includes screws to fix the dispenser to ASSA4. Max roll Ø 120 mm and width 50 mm.			FTD50
10. Basic label dispenser	Feeds labels from a roll, space for several rolls. Fits on ASSA4 or can be placed in a shelf or tray. Can be fixed with screws. Max roll Ø 220 mm and width 210 mm.			BLD20
11. Document holder A4	Steel document holder fixed on upright tube. Easily adjustable with the double arm. Max load 5 kg.			928 49 008P
12. Equipment tray	With double arm and handle. For small tools and packing accessories such as BLD20. Max load 15 kg.		500 x 250 x 125	928 49 002P

Please visit our webpage for full range of module M750 and M900 accessories.



+

All packing solutions in one place!

[Treston website](#) features all packing products in one place. For example different storage systems for packing, such as FiFo Flow Rack, a flexible flow-through shelving and storage solution.



Design your own packing station with our 3D Online Configurator

3d.treston.com



The Treston 3D Configurator can be used to design a packing workstation that best meets your needs. To get started, all you need is a mobile phone or a computer with internet browser; no downloading is required and using the software is free of charge.

Begin with the most popular pre-configurations in this article: treston.com/blog/improve-your-packing-process-ergonomic-packing-bench



Treston packing benches



- ✓ Sturdy and stable
- ✓ Modular, enabling a multitude of configurations economically
- ✓ Generous surface area
- ✓ Widest range of accessories accommodating any combinations

Whether you have a small web shop or represent larger numbers of manufacturing, logistics centre or spare parts store, don't hesitate to contact Treston experts for service and speedy delivery.



Download **free eBooks**



Increasing productivity with proper ergonomics

This informational e-book will help you learn how ergonomic environments can have a direct influence on employee well-being, the reduction of time and waste, and ultimately, greater productivity.



6-point checklist for creating and maintaining ESD-protected areas

This informational e-book lists 6 steps for setting up an ESD-protected area in your workplace. No matter whether you need just one workbench or a full-scale production line, the same principles apply to ensuring that ESD protection functions as it should.



LEAN thinking perfects production processes

This e-book will help you understand LEAN philosophy and how Treston, as a manufacturer of technical facilities and ergonomic furniture, can help you with the LEAN thinking to perfect your production processes.

These and more educative and useful e-books available on our website:

treston.com/catalogues-and-brochures



Product animations, informational videos and more!

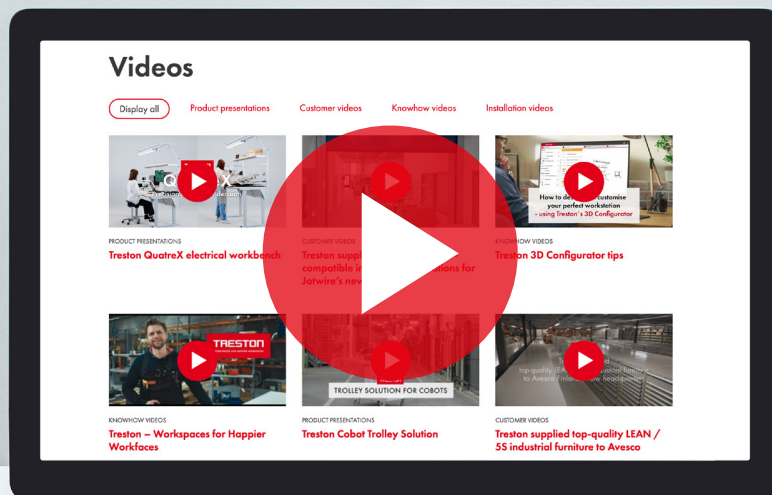

treston.com/videos

What our customers say



"Several competitor products we viewed didn't give us the same level of confidence, modularity and robustness"

– David Walch, Operations Director,
FT Technologies

CHRISTIE'S

"Treston was a great partner in designing a custom packing bench and worktable solution for Christie's."

– Emily Sarokin,
Christie's Auction House NYC



"The two most important goals were ergonomics and efficiency. This we have reached by using Treston."

– Lisanne Broer-van Abeelen,
bol.com fulfilment center



"Thank you for the informative day at Treston. Your great team impressed me with their knowledge."

– M. Huber, Kaiserslautern,
SKS Welding Systems GmbH



"SNCF chose Treston for high quality, ergonomics and modularity enabling future modifications ."

– David Lacour, Head of Proximity
Tachometry, SNCF Mobility

Read all our customer stories at:

[treston.com/about-us/
customer-stories](https://treston.com/about-us/customer-stories)

HEADQUARTERS

Treston Oy
Sorakatu 1
FI-20730 Turku
Tel. +358 10 4469 11
sales@treston.com
www.treston.com

FACTORIES

Treston Oy, Turku plant
Sorakatu 1
FI-20730 Turku
Tel. +358 10 4469 11
sales@treston.com
www.treston.fi

Treston Oy, Jyväskylä plant
PO Box 33 (Sohlberginkatu 10)
FI-40351 Jyväskylä
Tel. +358 10 4469 11
sales@treston.com
www.treston.fi

FRANCE

Treston France SARL
Z.A.C. de la Bonne Rencontre
1, voie Gallo Romaine, Quincy-Voisins
77334 Meaux Cedex
Tel. +33 1 64 17 11 11
infofr@treston.com
www.treston.fr

GERMANY

Treston Deutschland GmbH
Friedrich-Ebert-Damm 143
22047 Hamburg
Tel. +49 40 8816 5022 - 0
info.de@treston.com
www.treston.de

Treston Deutschland GmbH
Niederlassung Raunheim
Frankfurter Straße 101
65479 Raunheim
Tel. +49 6142 992 50
mail.de@treston.com
www.treston.de

SWEDEN

Treston AB
Polygonvägen 73
187 66 Täby
Tel. +46 8 511 791 60
info.se@treston.com
www.treston.se

UNITED KINGDOM

Treston Ltd
Treston House
5b Bone Lane, Newbury
Berkshire, RG14 5SH
Tel. +44 1635 521521
salesuk@treston.com
www.treston.com

USA

Treston, Inc.
156 Bluffs Court
Canton, GA 30114
Tel. +1 770-721-7980
infousa@treston.com
www.treston.us

PREMIUM PARTNERS:

BENELUX

Human Workspace BV
Mechelaarstraat 17
4903 RE Oosterhout
Tel. +31 162 454 383
sales@humanworkspace.nl
www.humanworkspace.nl

NORWAY

Industrimøbler AS
Bjørnerudveien 12A
1266 Oslo
Tel. +47 22 25 05 00
post@industrimobler.no
www.industrimobler.no



Thanks to our global sales network, you can receive local support and customer service anywhere in the world.

Find your nearest retailer: www.treston.com/contact-us

TRESTON

Workspaces for happier workfaces.

This is our aspiration. This is our promise. This is what Treston is all about.

With decades of experience, in-depth understanding of ergonomics in industrial environments, unmatched ESD competence and proven LEAN knowhow we at Treston are in a unique position to help our customers in keeping their business and people in good shape.

treston.com

CHRISTIE'S

"Treston was a great partner in designing a custom packing bench and worktable solution for Christie's."

– Emily Sarokin,
Christie's Auction House NYC

bol.com

"The two most important goals were ergonomics and efficiency. This we have reached by using Treston."

– Lisanne Broer-van Abeelen,
bol.com fulfilment center